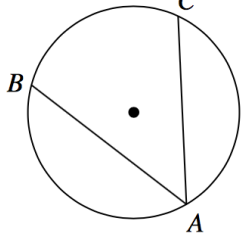
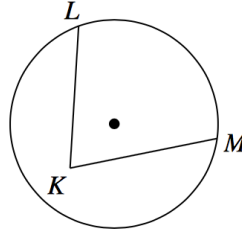
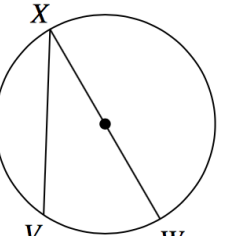
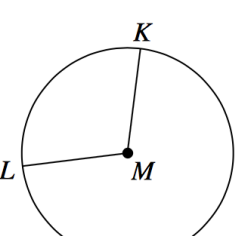
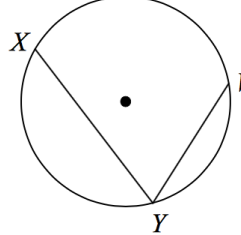
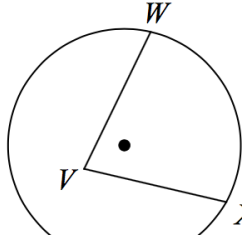
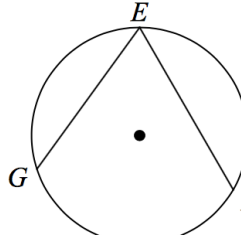
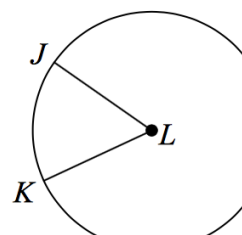

Name:

Date:

10.4 Inscribed Angles and Polygons

State if each angle is an inscribed angle. If it is, name the angle and the intercepted arc.

1. 	2. 
3. 	4. 
5. 	6. 
7. 	8. 

Find the measure of the arc or angle indicated.

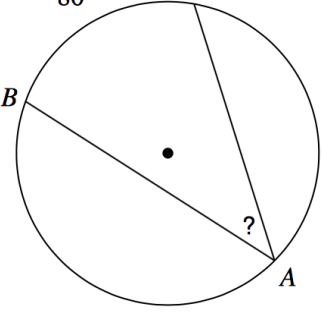
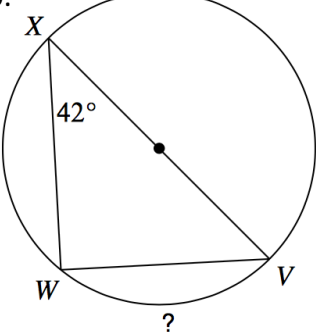
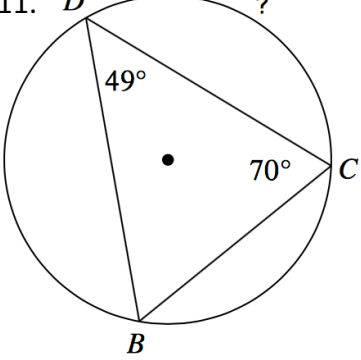
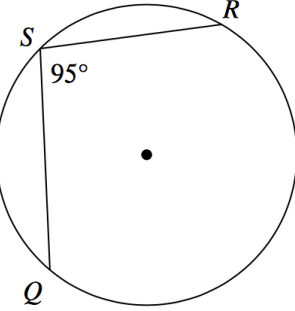
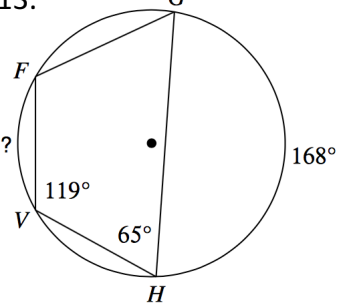
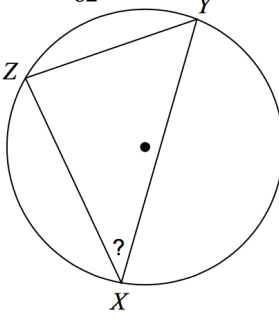
<p>9. 80°</p>  <p>A circle with center dot. Points A, B, and C are on the circumference. Angle C is labeled 80°. Angle A is labeled with a question mark $?$.</p>	<p>10.</p>  <p>A circle with center dot. Points X, W, and V are on the circumference. Angle X is labeled 42°. Arc WV is labeled with a question mark $?$.</p>
<p>11. 49° 70° $?$</p>  <p>A circle with center dot. Points B, D, and C are on the circumference. Angle D is labeled 49°. Angle C is labeled 70°. Arc BD is labeled with a question mark $?$.</p>	<p>12. 75° 95° $?$</p>  <p>A circle with center dot. Points S, Q, R, and Q are on the circumference. Angle S is labeled 95°. Angle R is labeled 75°. Arc SQ is labeled with a question mark $?$.</p>
<p>13. 119° 65° 168° $?$</p>  <p>A circle with center dot. Points F, V, G, H, and G are on the circumference. Angle F is labeled 119°. Angle V is labeled 65°. Angle H is labeled 168°. Arc FG is labeled with a question mark $?$.</p>	<p>14. 82° $?$</p>  <p>A circle with center dot. Points X, Y, and Z are on the circumference. Angle Y is labeled 82°. Angle X is labeled with a question mark $?$.</p>

15. Find $m\widehat{EDC}$

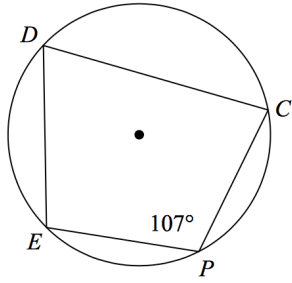

16.

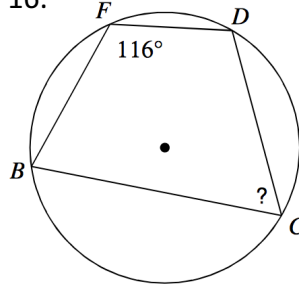

17.

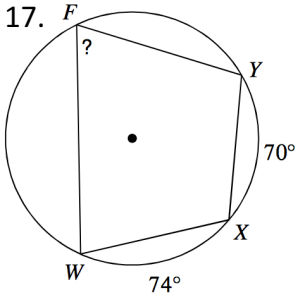

18. Find $m\widehat{PR}$

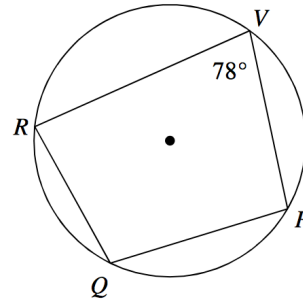

19. Find $m\widehat{QRS}$

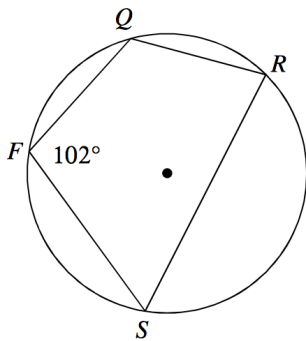

20.

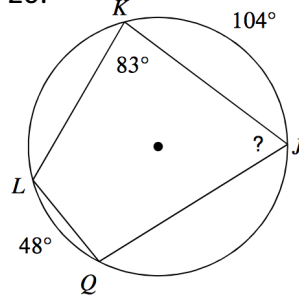

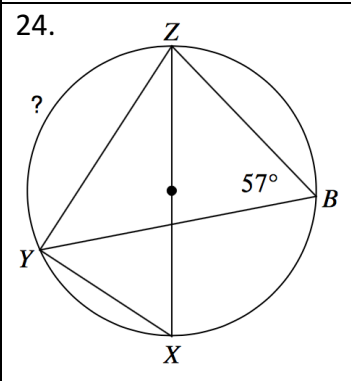
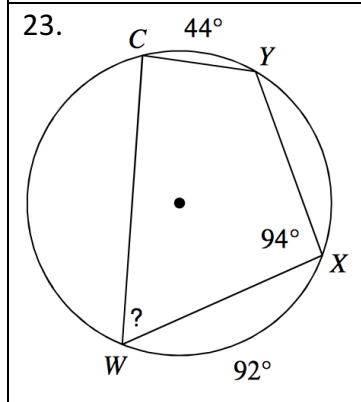
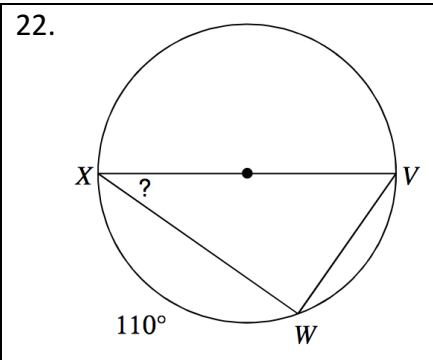
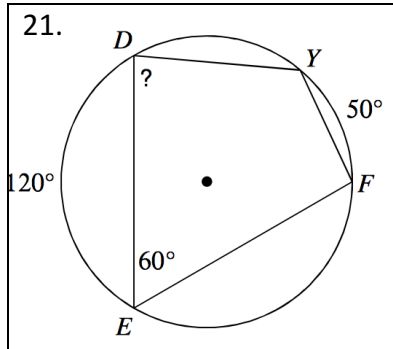

Solve for x .

25.

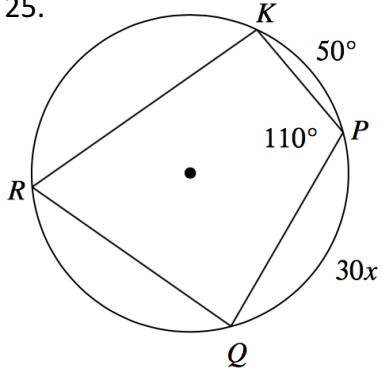

26.

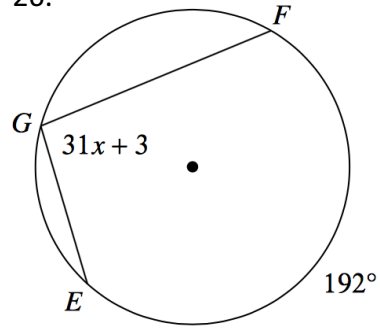

27.

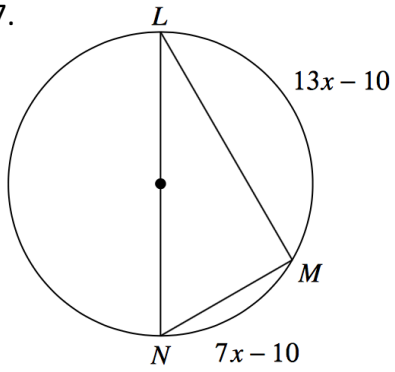

28.

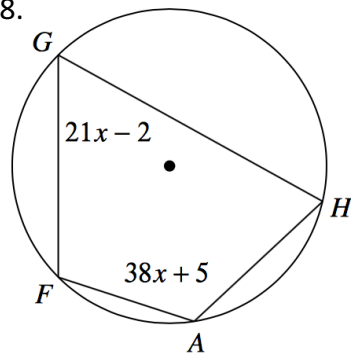

29.

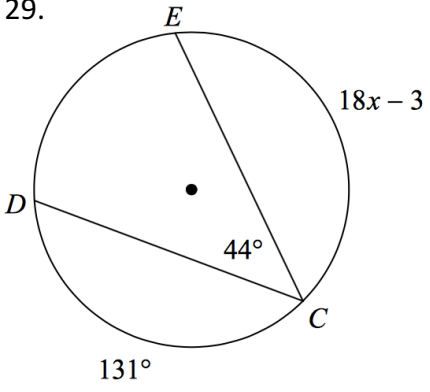

30.

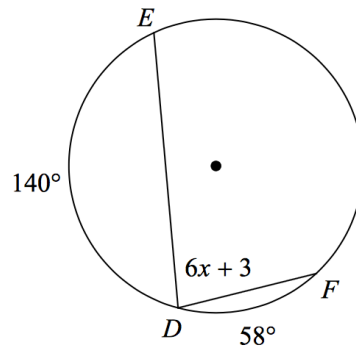

31.

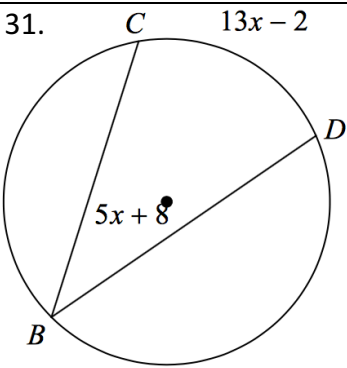

32.

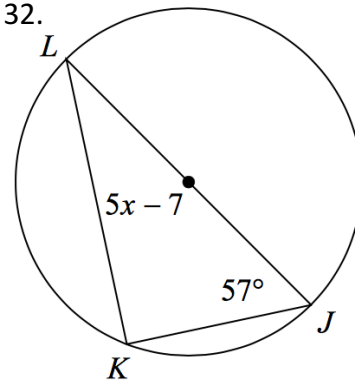

33.

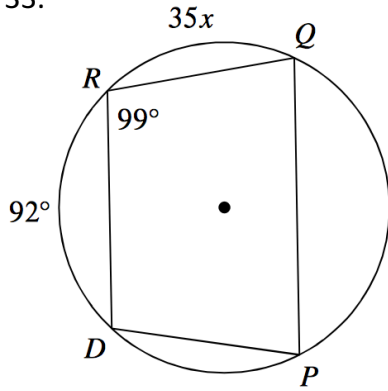

34.

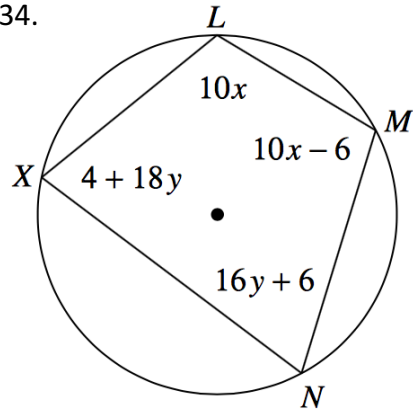

35.

